

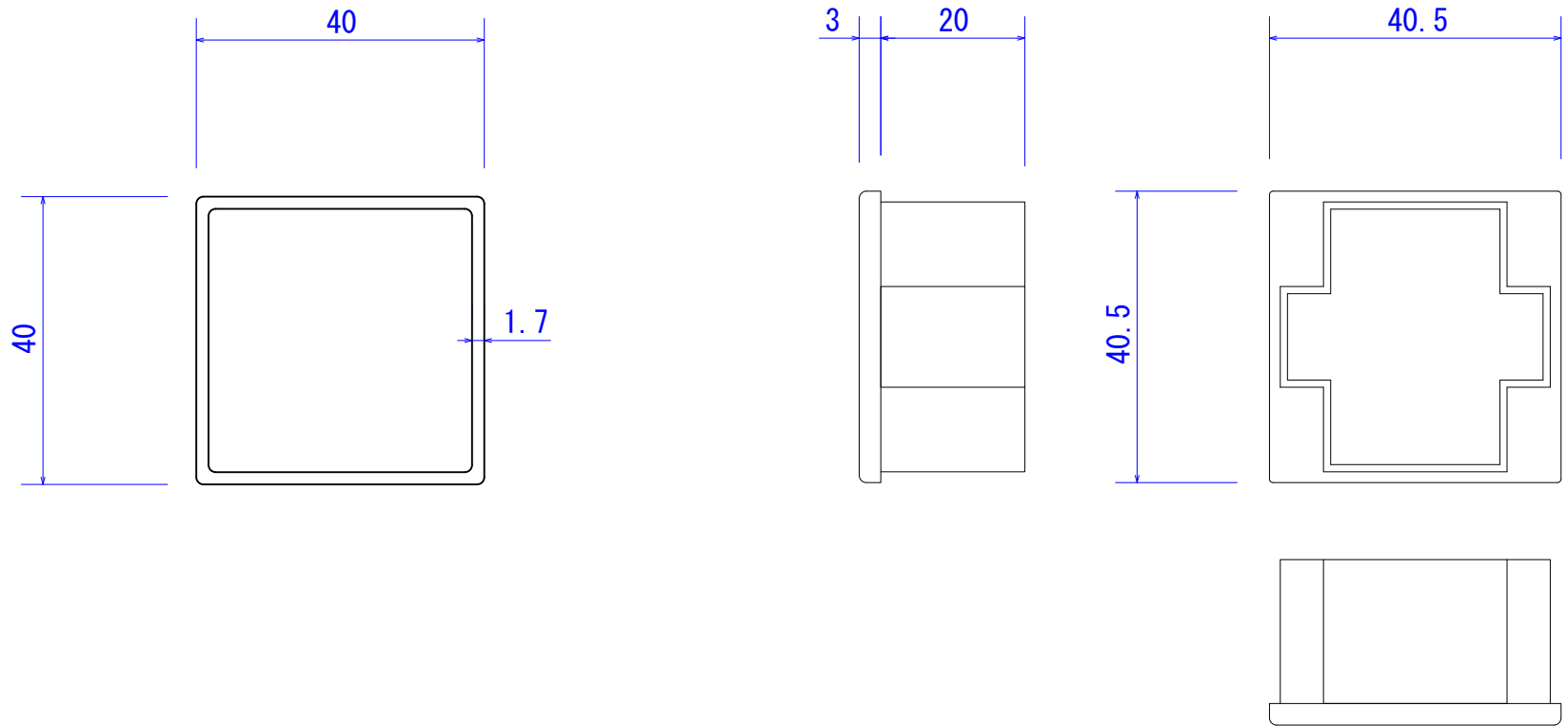





# Koshi batten detail

## Profile: Square 40x40

Weight: 0.703kg/m  
 Batten thickness: 1.7mm  
 End cap thickness: 3.0mm  
 End cap: Coloured ABS plastic





### Endcap detail



			Product Name				Project Name	Date	Page	Scale	Projection	
			KOSHI SQUARE 40X40					07/2021	1 of 2	1:1		
			Approval	Check	Drawing	Design			Melbourne Showroom 2 Ginibi Drive Altona North VIC 3025		T +613 9398 8128 info@covet.com.au www.covet.com.au	
	Install	Never strike extrusion directly with a hammer or rubber mallet. Use a pine plank between the tool and the extrusion to avoid surface damage or denting.										
	End Caps	Screw fix or apply exterior grade adhesive (Sikaflex) to secure cap to batten.										

## Koshi Batten Installation Guide

- Aluminium can be damaged if mishandled. Never strike directly with a hammer or rubber mallet. Use a pine plank between the striking rubber mallet and the extrusion to avoid surface damage or denting.
- Cut aluminium with a drop saw using an aluminium blade.
- Always cap ends of extrusions with supplied end caps or a flashing to avoid moisture ingress.
- Metal end caps (painted) must be screwed to the extrusion.
- All end caps can only be applied to straight 90 degree cuts. They cannot be applied to angle end cuts.
- Ensure appropriate screws are used to suit the substrate you are fastening to. It is important to use stainless steel or bi-metal screws for all metal surfaces impacted when fastening (i.e. furring channels, top hats, steel frames). This will prevent galvanic reaction between the screw/substrate and aluminium extrusion.
- Fasten at maximum 1 metre spans. Please contact Covet for further information.

		Product Name				Project Name	Date	Page	Scale	Projection
		KOSHI BATTENS					07/2021	2 of 2		
										
	Install	Never strike extrusion directly with a hammer or rubber mallet. Use a pine plank between the tool and the extrusion to avoid surface damage or denting.	Approval	Check	Drawing	Design			Melbourne Showroom 2 Ginibi Drive Altona North VIC 3025	
	End Caps	Screw fix or apply exterior grade adhesive (Sikaflex) to secure cap to batten.								